

Art. Nr. 2835096

1/6



30.10.2023





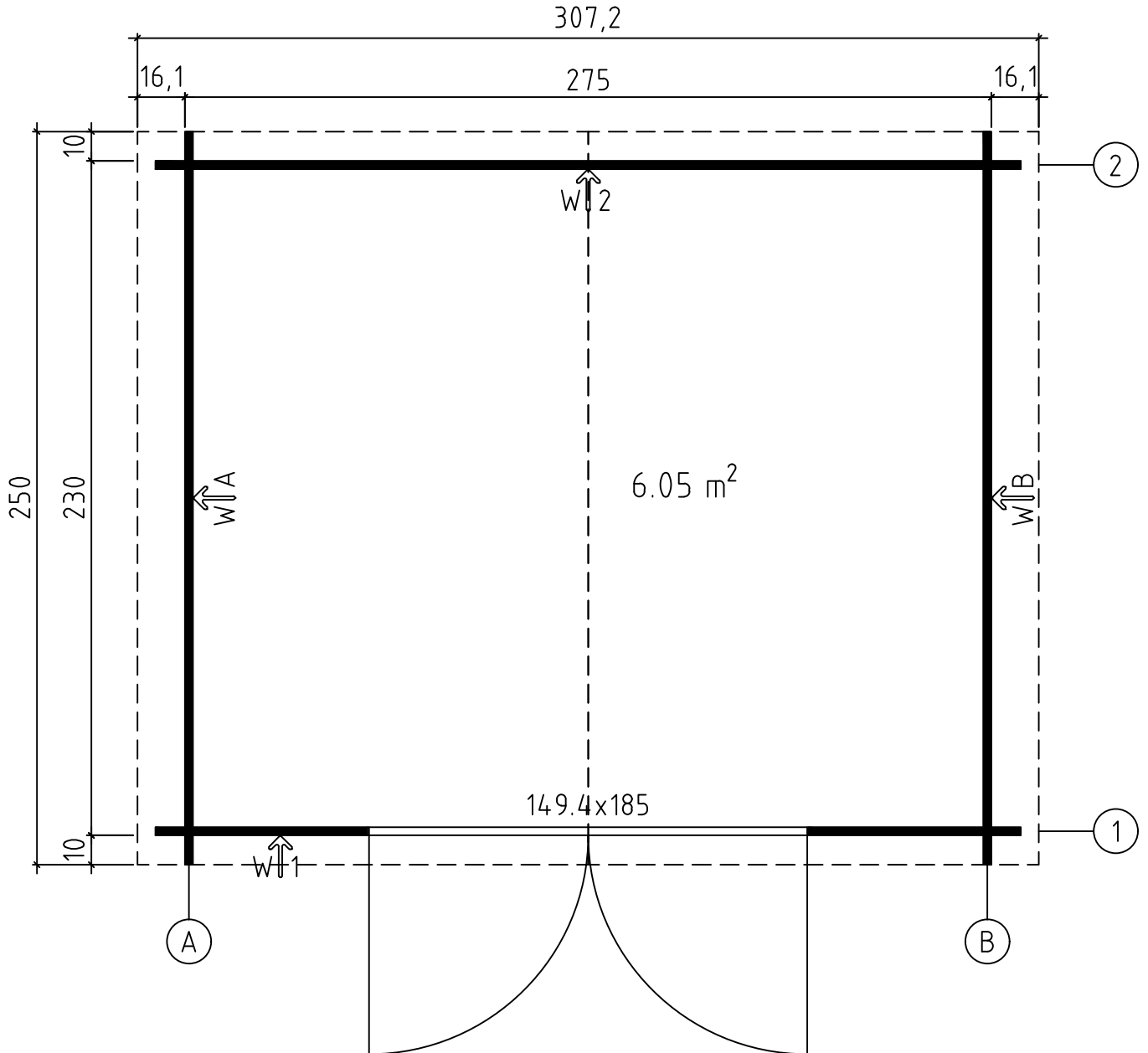

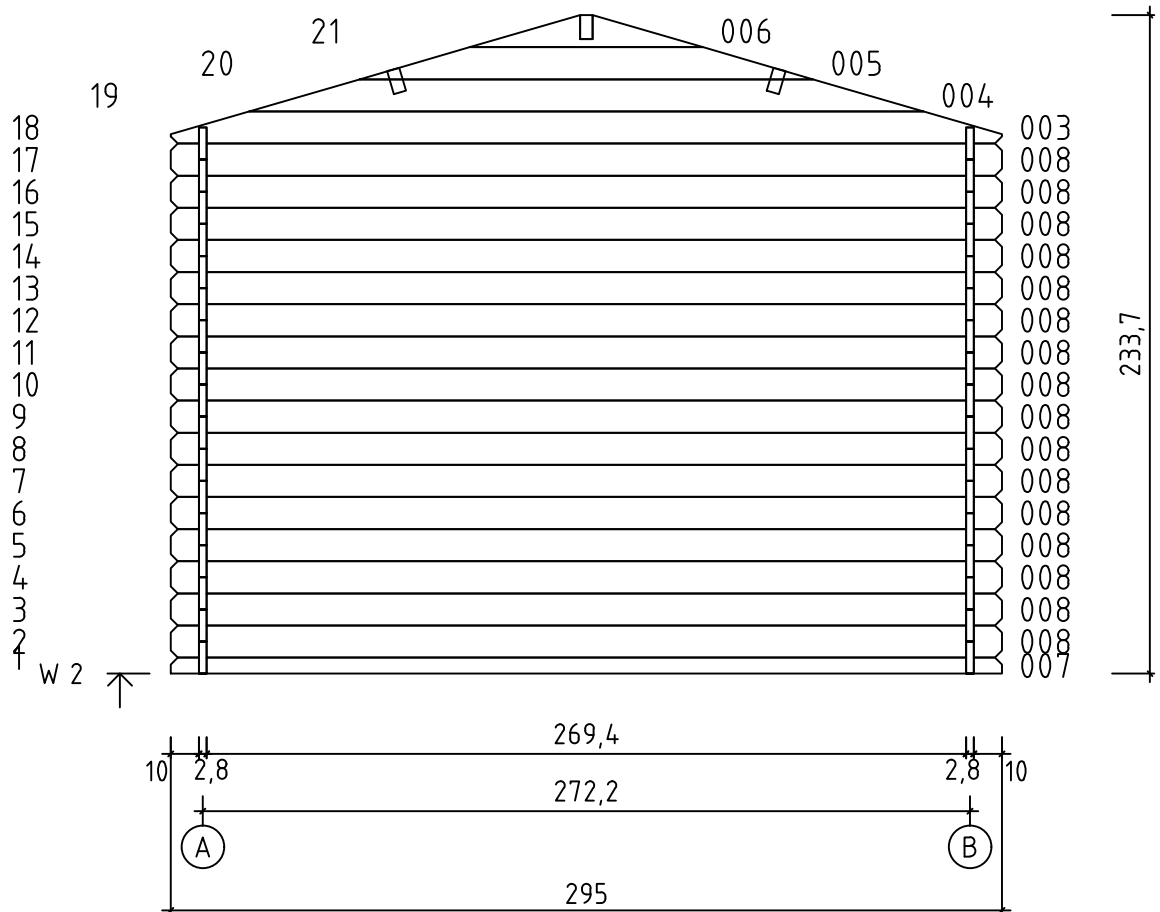
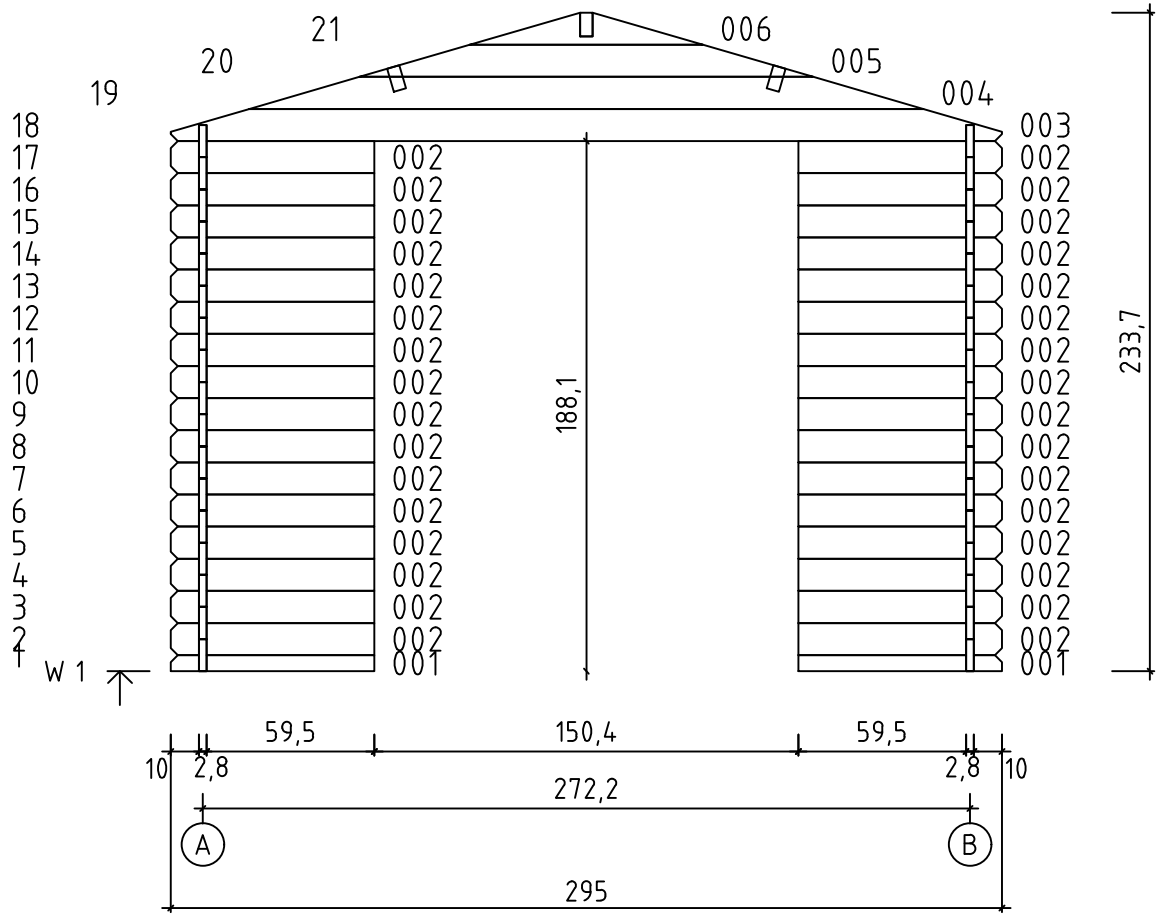

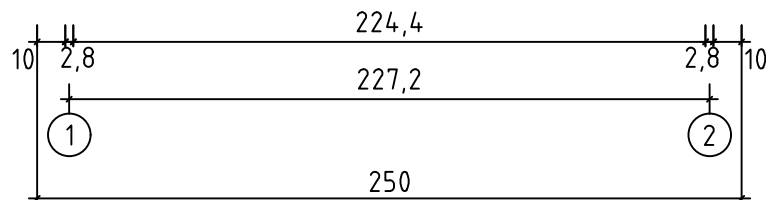
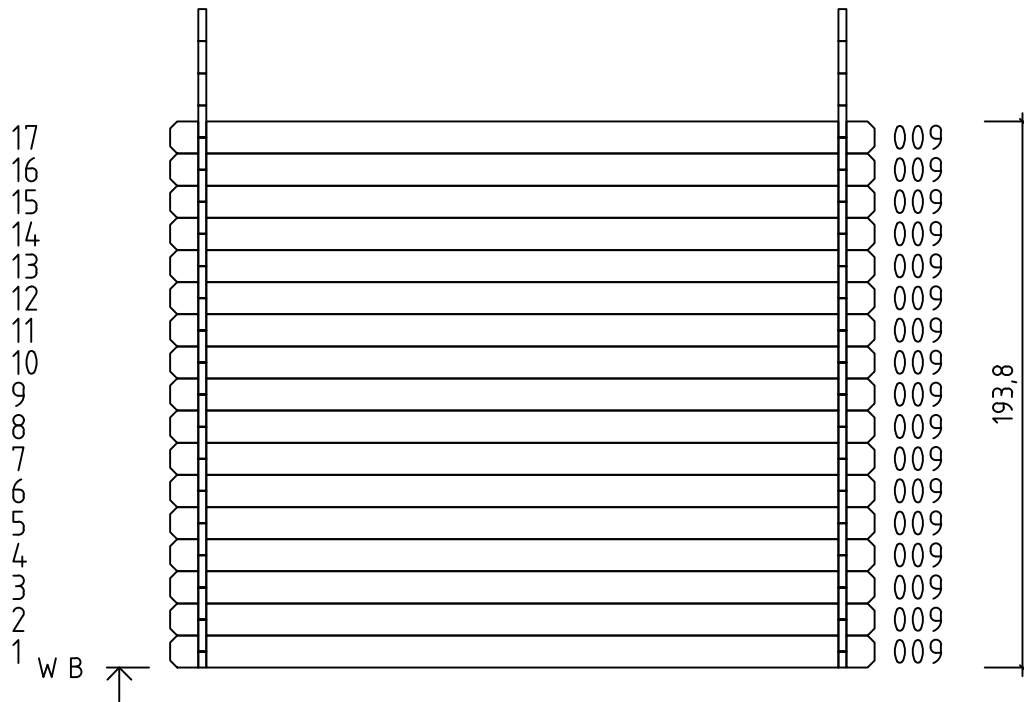
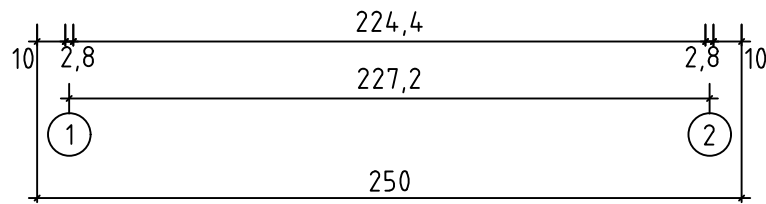
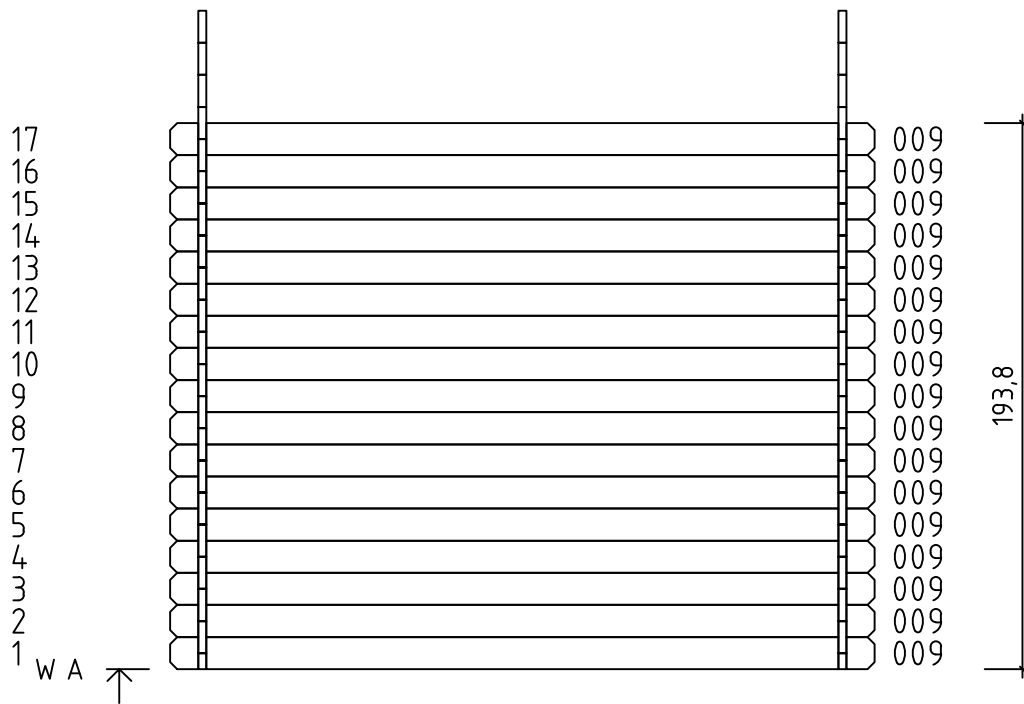

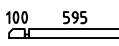
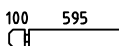
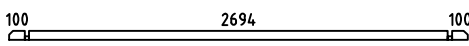
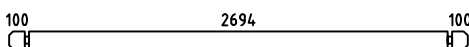
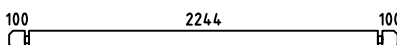
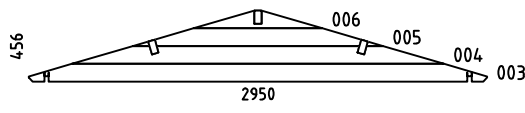
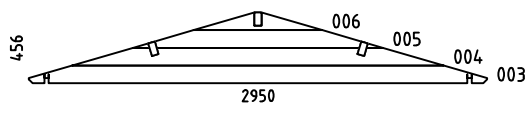
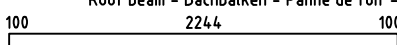

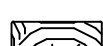
Art.Nr. 2835096

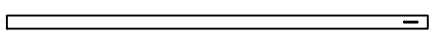
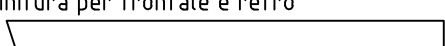





Groundplan - Grundplan - Plan de masse - Planimetria - Plattegrond - Põhiplaan



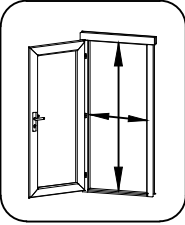
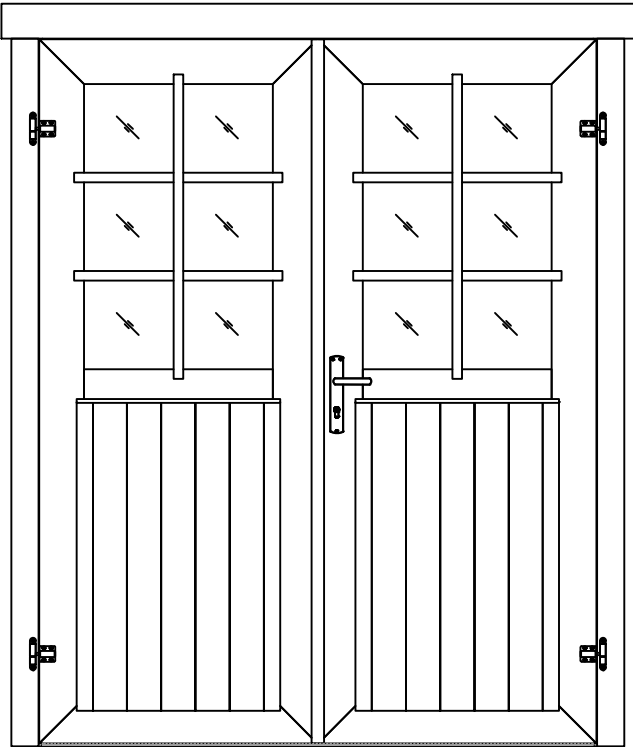

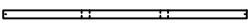
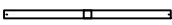

Pos	30.10.2023 Piece list - Stückliste - Liste des pièces - Elementi - Stuklijst - Joonis Art.Nr. 2835096	5/6	Q	P (mm)	L (mm)
001			2	28x57	723
002			32	28x114	723
007			1	28x57	2950
008			16	28x114	2950
009			34	28x114	2500
W1-1			1		
W2-1			1		
A-PR1	Roof beam - Dachbalken - Panne de toit - Perlina del tetto - Gordingen / dakbalk - Abipärliinid 		3	44x120	2500
	Roof boards - Dachbretter - Voliges - Perlina per tetto - Dakhout - Katuselaud 		56	90x15.5	1600
	Roofing felt fillet - Dachpappenleiste - Baguette de fixation du feutre bitumeux - Asse per fissaggio guaina bituminosa - Afdekljst asfaltpapier - Katusepapiliist 		4	15x45	1650
DRV-1	Roof edge reinforcement - Dachrandverstärkung - Corniere de renfort de bord de toit - Rinforzo x tetto - Dakrand versterking - Räästatugevdus 		2	15x45	2500
KFS-1	Storm protection - Sturmleiste - Latte anti-tempete - Protezione anti vento - Stormverankering / beveliging - Tormikinnitus 		4	22x45	2050
	Gable moulding - Giebelleiste - Planche de rive - Finitura per frontale e retro del tetto - Gevellijst - Viilulaud 		4	15x120	1650
HS8	Screw for gable segment - Schrauben für deckblatt - Vis pour fixation losange de finition - Viti x frontali tetto - Schroef voor gevelpunt segment - Kruvi rombile 		4	3.5x35	
HS9	Screw for gable moulding - Schrauben für giebelleiste - Vis pour fixation planche de rive - Vite per fissare finiture davanti e dietro del tetto - Schroef voor gevellijst - Kruvi viilulauale 		24	3.5x50	
HS4	Screw for roof edge reinforcement - Schrauben für dachrandverstärkung - Vis pour fixation corniere renfort de bord de toit - Viti x rinforzo bordo tetto - Schroef voor dakrand versterking - Kruvi räästatugevdusele 		12	3x30	
HS18	Screw for roof beams - Schrauben für dachbalken - Vis pour fixation pannes de toit - Viti per perline del tetto - Schroef voor gordingen / dakbalken - Kruvi pärlinitele 		6	5x120	
HS18	Screw for gable - Schrauben für giebel - Vis pour fixation des pignons - Viti per timpano - Schroef voor gevelpunt - Kruvi viilude kinnitamiseks 		4	5x120	
SH28	Hammer block - Schlagholz - Calle de frappe - Blocco di legno da usare come cuscinetto quando si usa il martello - Slagklos - Löögiklots 		1		
SFS	Nut for storm protection - Schraubenmutter für sturmleiste - Ecrou pour latte anti-tempete - Dado x asta protezione vento - Moer voor stormverankering - Mutter tormikinnitusele 		8	D6	
NF4	Zn nail for roof - Zn nagel für dachbretter - Pointe pour fixation voliges de toit - Chiodi x perline tetto - Spijker(nagel) voor dakhout - Nael katuselauale 		186	2x50	

Pos	19.12.2017	Piece list - Stückliste - Liste des pièces - Elementi - Stuklijst - Tükítabel 14 94x1850 TUK.2.056.SVP.MMX28 SGA+28	1/2	Q	P (mm)	L (mm)
Glass size - Glasgröße - Taille de la vitre - Misura del vetro - Glas afmeting - Klaasi mõõt: 502x750 mm				 1418x1794 mm		
						
1	Upper door jamb - Türrahmen oben - Cadre de porte supérieur - Telaio superiore della porta - Bovendorpel - Ukse ülemine leng			1	66x100	1438
2	Left door jamb - Türrahmen links - Cadre de porte gauche - Telaio montante sinistro della porta - Linkerstijl deurframe - Ukse vasak leng			1	66x80	1850
3	Right door jamb - Türrahmen rechts - Cadre de porte droit - Telaio montante destro della porta - Rechterstijl deurframe - Ukse parem leng			1	66x80	1850
4	Doorstep - Swelle - Barre de seuil - Soglia della porta - Deurdorpel - Lävepakk			1	20x21	1418
5	Connection strip - Deckleiste - Baguette de battement - Profilo verticale della porta - Stulplijst - Kokkuvalltsiliist			1	13x32	1812
6	Georgian bars - Sprossen - Croisillons - La griglia georgiana - Raamverdeling - Petteliistud			2	15x25	784
7	Georgian bars - Sprossen - Croisillons - La griglia georgiana - Raamverdeling - Petteliistud			4	15x25	536



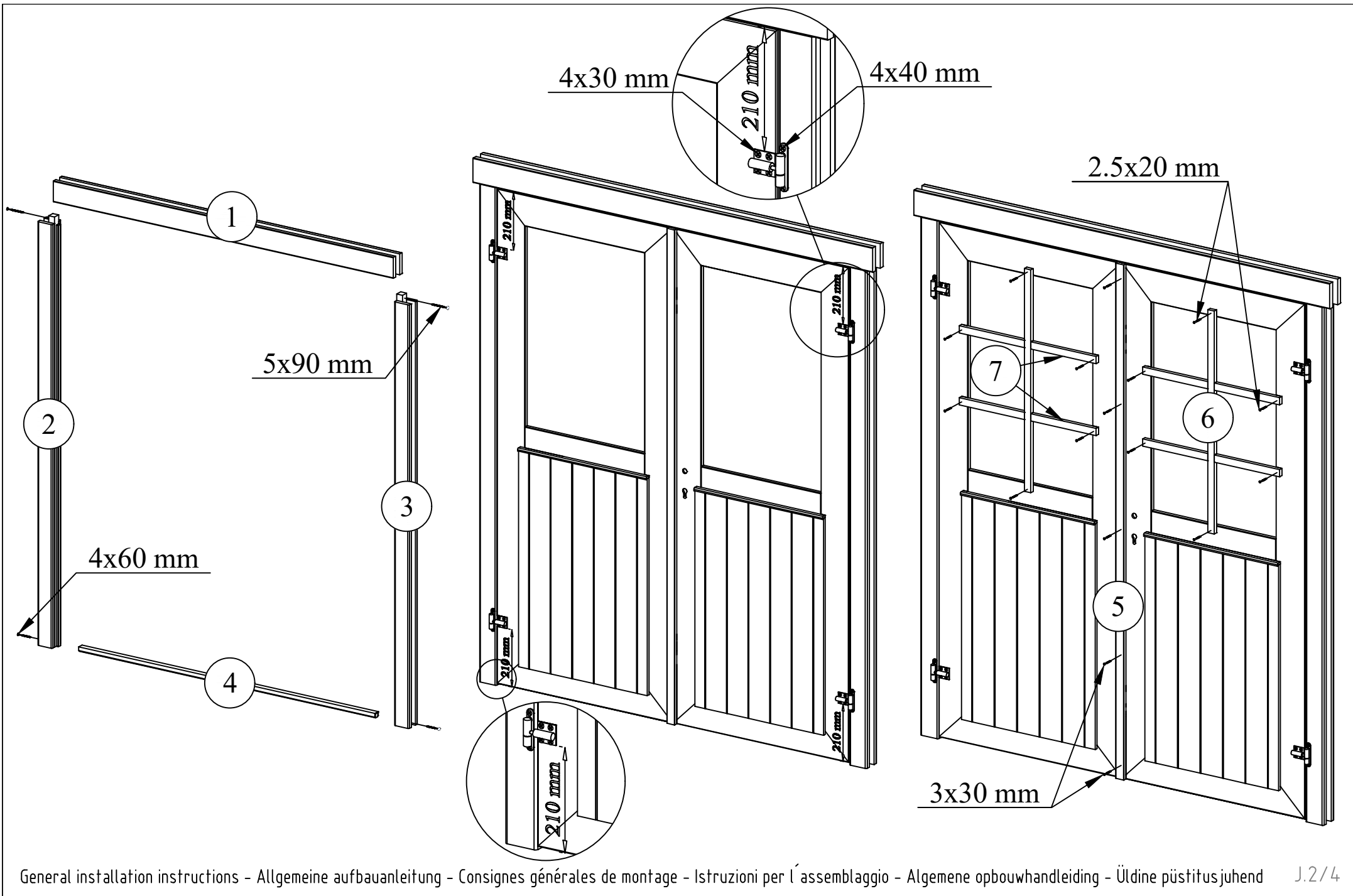

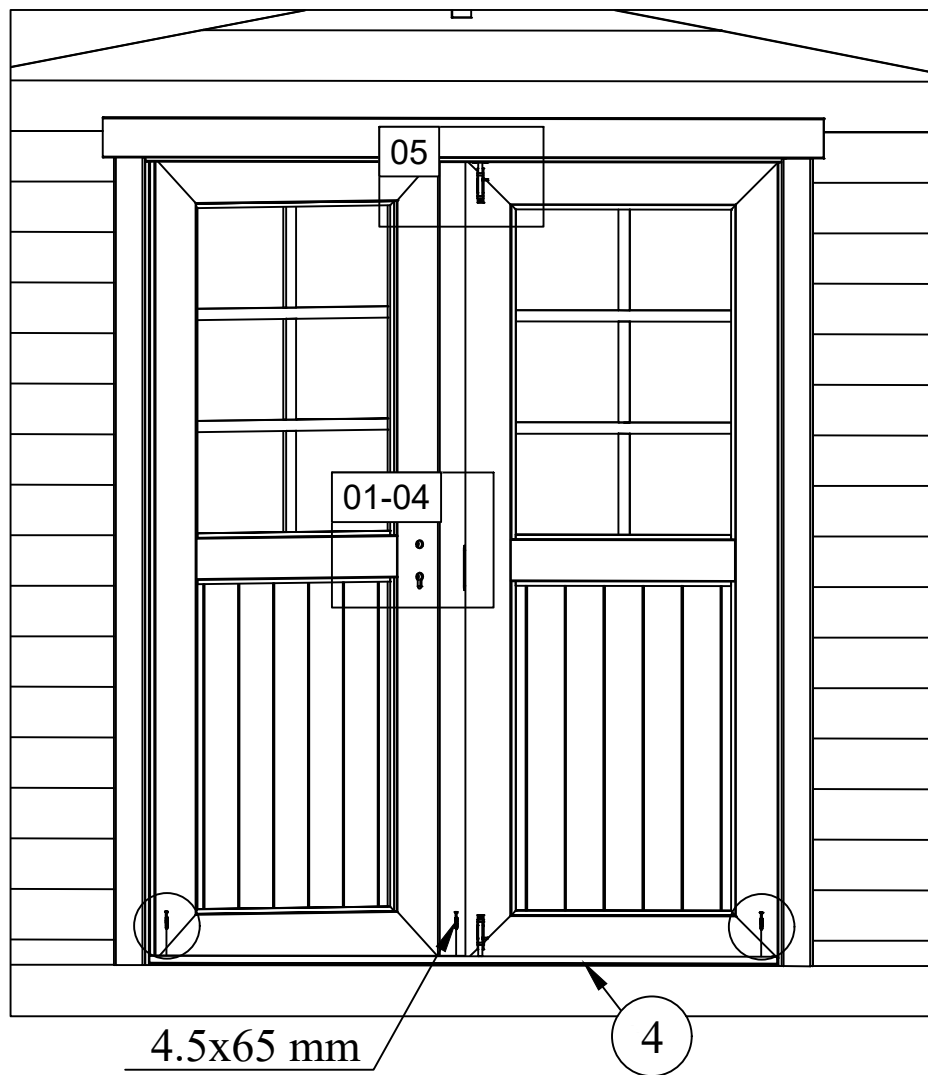

01



04



02



05

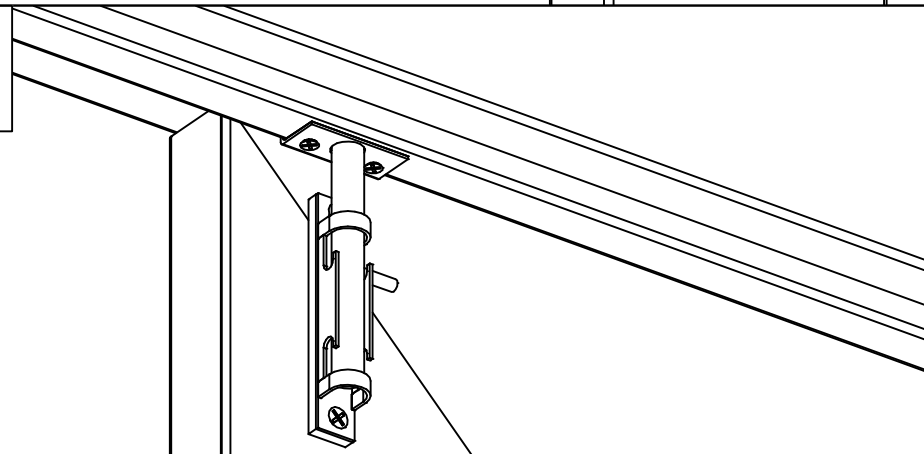

03



06

